

Maintenance Instructions

Replace ultraviolet lamps every **eight months** of use to maintain optimum performance of the unit.

At eight months of continuous use the UV output of the lamp have lost approximately 30% of the effectiveness and should be replaced. After this time the lamp may still light but is no longer emitting enough of the special UV light frequency required for an effective insect catch.

All other services:

Any other servicing other than cartridge or UV lamp replacement, should be performed by an authorized service representative.

Call, email, or Fax **Paraclipse** for the name of the nearest service representative.

Care and Cleaning of Unit:

For the best results your Paraclipse™ Terminator should be cleaned regularly when you change the cartridge.



When cleaning do the following:

1. Disconnect unit from electrical outlet.
2. Use glass cleaner to clean the body of the trap and bulbs. Make sure you remove excess insect droppings and dead carcasses.
3. Dry trap thoroughly with soft cloth.
4. Reconnect to electrical outlet.

Ultraviolet Reflector:

The specialized UV light reflector may become dirty or dusty, clean with non-abrasive glass cleaner and soft cloth.



Use Only Genuine Paraclipse replacement Cartridges and Ultraviolet (UV) lamps to Maintain your Paraclipse product in proper working order. Use of Non-Paraclipse Replacement parts may cause damage to your Paraclipse equipment and may void warranty.

Replacement Parts or additional units:

For replacement parts contact your dealer. Call or Fax Paraclipse, Inc. for the nearest dealer.

UV Lamps: #72917

Shatter proof UV Lamps: #72918

12 Pack of Cartridges: #73892

To order additional units:

251350 White or 271350 White One Sided

Paraclipse®
2271 East 29th Ave.
PO Box 686
Columbus, NE 68602-0686 USA
Phone: (402)563-3625
Fax: (402) 564-2109
Email: contact@paraclipse.com
Web site: www.paraclipse.com

Paraclipse®

Automated Insect Control Division

Paraclipse™ Terminator



A Fly's Worst Enemy

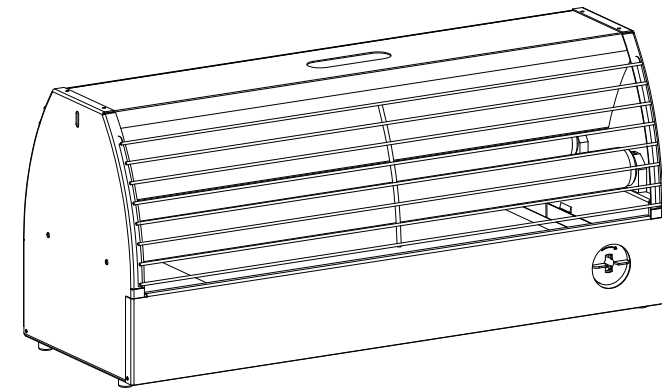

SAVE THESE INSTRUCTIONS

Table of Contents

Mounting Locations	Page 3
Mounting Options	Page 4
Ultraviolet Lamp Insertion	Page 5
Cartridge Insertion	Page 6
Manual Paper Advance	Page 6
Cartridge Alarm	Page 7
Maintenance	Page 8

IMPORTANT SAFETY INSTRUCTIONS



This symbol is intended to alert you of the presence of dangerous voltage within the unit's enclosure that maybe of sufficient magnitude to constitute a risk of electric shock.



This symbol is intended to alert you of the presence of important operating and maintenance instructions accompanying the unit.



Caution! To reduce the risk of electric shock, observe the following:

1. Do not remove the motor enclosure. No user serviceable parts are inside.
2. **This product is intended for use indoors only! Do not use where it may be exposed to water or direct sunlight (including roofed but open porches).**
3. Use only extension cords marked SPT-2, or equivalent. Its electrical rating must be at least 120 V, 60 Hz, and 1 Amps. Use only extension cords which have plugs and receptacles which accept product's plug.
4. Replace or repair damaged cords.
5. Don't abuse cord. Never carry product by cord or yank it to disconnect it. Keep cord from heat, oil, and sharp edges.
6. **Disconnect the product from power supply when not in use, before serving, or when changing bulbs.**
7. Extension cords & devices for retaining an extension cord connection to the power supply cord are available.

CAUTION! To avoid risk of contamination, observe the following: Dead insects are unsanitary. Use care in removing used cartridge.

CARTRIDGE ALARM

Cartridge Alarm

The Paraclipse™ Terminator has a design feature unique audible beep when it is time to replace the cartridge.

The alarm is triggered when the paper no longer covers the hole in the top of the paper holder plate (fig. 8). An electronic light sensor recognizes this and begins to emit a high pitched beep.

Fig. 8

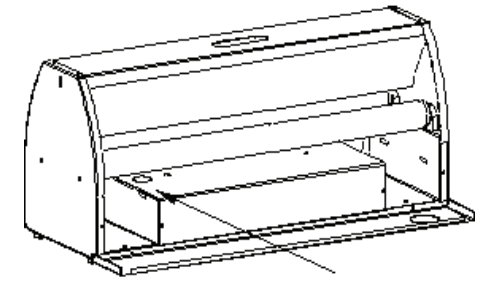

Cartridge Alarm Sensor Hole

Testing:

To test the operation of the alarm follow these steps:

1. Lower the cartridge door.
2. Carefully remove the cartridge. The alarm should emit an audible beeping.
3. Stop the alarm by installing a fresh cartridge.

Note: If new cartridge is not available for installation, unplug the unit to shut off the alarm until a genuine Paraclipse replacement cartridge is available.

CARTRIDGE INSERTION & MANUAL PAPER ADVANCE



DEAD INSECTS ARE UNSANITARY

Cartridge Insertion

The tacky cartridge paper and unique motor drive system are the heart of this state of the art insect trap. The ease of changing the cartridge and safety provided (because of the unsanitary dead insects) sets your Paraclipse™ Terminator trap apart from the others. The tacky cartridge can also be used as an aid in monitoring insect types and volumes. The side of the paper is marked every 3" with a different thickness line. The 3" lines get thicker and repeats every 21" as the paper advances.

1. New Unit:

Your Paraclipse™ Terminator is shipped with cartridge preinstalled. You will need to advance the cartridge until the glue surface spans the full length of the cartridge. (fig. 7, step 5)

2. Replacement Cartridges: (Reference fig. 7 for all steps)

Step 1- To install a replacement cartridge lower the cartridge door.

Step 2 - Unsnap the new halves to separate.

Step 3 - Slowly pull apart the cartridge halves and unwind paper so the cartridge halves are approximately 16" (41 cm) apart.

Step 4 - Insert cartridge halves into place. Making certain the roll of paper is on the left side and the right side is engaged with the motor drive shaft.

Step 5 - Close the cartridge door. Manually advance the drive spool of the cartridge in the direction of the arrow on the drive spool until the glue surface spans the full length of the cartridge.

Use the same procedure when installing a new cartridge and advancing the paper due to heavy insect catch.

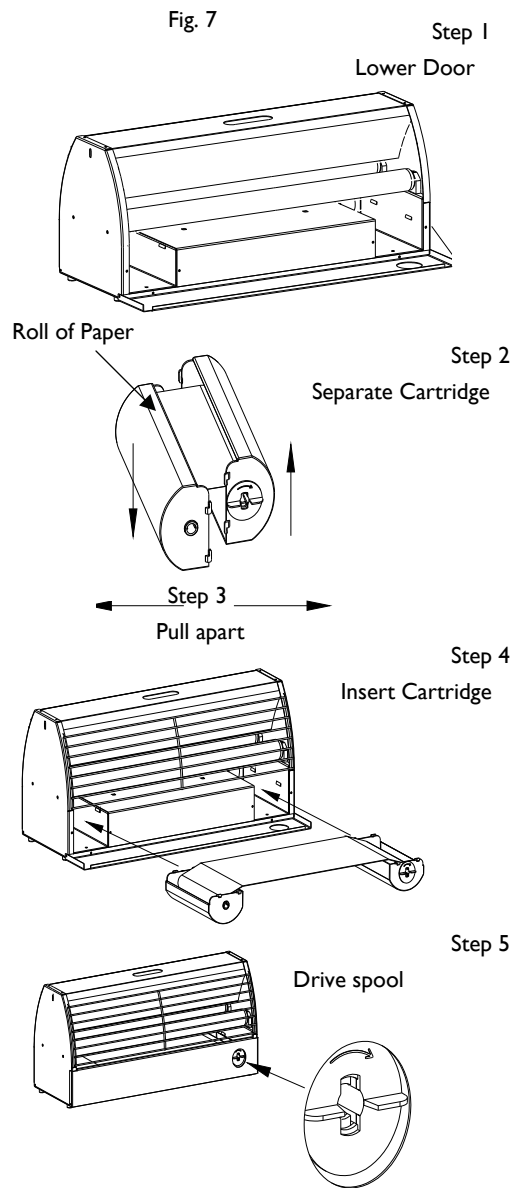

72955-5-6-2014

Mounting Instructions

Your Paraclipse™ Terminator will attract and catch many types of insects. The trap's superior effectiveness is based on an insects' desire to be attracted to the integrally designed ultraviolet light source and specialized attractants. Trap Placement is important to optimize the performance to the trap. Traps installed in areas without obstruction can cover up to about 4000 square feet (750 square meters). For best results follow the below listed guidelines.



1. Select an area (see fig. 1) near an electrical outlet or plan to bring an electrical source to the area. The simplest installation is to place the trap within 6' (1.8m) of an electrical outlet. This may not always be practical, it may be necessary to wire a new source of electricity near the ideal trap placement location. If a new source of electricity is required seek the help of a qualified electrician.
2. Install near room entrances. This will maximize the chances the trap will catch the insects as they enter a room.
3. Install near areas of highest insect population.
4. Install in areas where room temperatures average above 50° F. Most insects like to be in a warm ambient temperature. Installing your trap in a warm room will help maximize the insect catch.
5. Install unit 4' to 6' (1.2 m to 1.8 m) above the floor.
6. **Do not install:**
 - Near competing light sources
 - Near water or other damp locations
 - Where traffic could possibly damage unit
 - Near excessive heat sources such as ovens or furnaces

Fig. 1

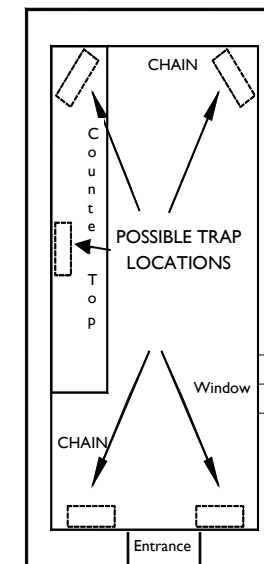

72955-5-6-2014

MOUNTING OPTIONS

Types of mounting:

Your Paraclipse™ Terminator can be mounted two different ways, to best fit your application.

1. Ceiling mounted: (fig. 2)

Using the chain and S hooks supplied mount your trap to ceiling supports.

Note: When mounting your Paraclipse™ Terminator to the ceiling be certain to take into account the trap location and suitable ceiling structure from which to hang your trap.

Note: Due to the variety of ceiling structures no hardware is supplied to attach to the ceiling. Be certain suitable lag bolts, toggle bolts, eye bolts etc. are used which will support up to 40 lbs. each.

2. Table mounting: (fig. 3)

Simply place the trap on a table in a suitable location near an electrical outlet.

Do not install:

- Near competing light sources
- Near water or other damp locations
- Where traffic could possibly damage unit
- Near excessive heat sources such as ovens or furnaces

Tip

Which ever mounting method you decide to go with you will maximize the performance by incorporating two main concepts.

1. Place Terminator trap 4' to 6' (1.2 m to 1.8 m) above floor.
2. Preferred color of wall is white or a light color if the Terminator unit has to be placed close to wall.

Fig. 2

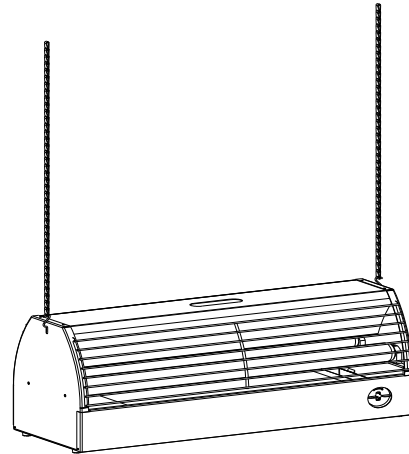
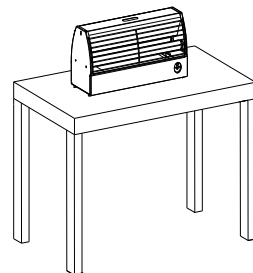

Fig. 3



72955-5-6-2014

ULTRAVIOLET LAMP INSERTION

Grill Removal and Installation: (fig. 4)

1. Removal:

Lift the grill up to a horizontal position and pull the grill out of the mounting holes.

2. Installation:

Align the grill end rods with the two mounting holes and push in while lowering the grill.

Lamp Protector Removal:

1. Carefully remove the cardboard from the two lamps. Check lamps to make sure they are secure in the light sockets. Discard the lamp protector cardboard. (fig. 5 and 6)

2. Reinstall grill.

Note: It is recommended to replace the ultraviolet lamps every **eight months** of use to maintain optimum performance of the unit.

At eight months of continuous use the UV output of the lamp have lost approximately 30% of the effectiveness and should be replaced. After this time the lamp may still light but is no longer emitting enough of the special UV light frequency required for an effective insect catch.

Replacement bulbs: part # 72917

Troubleshooting:

If the lamps will not light check the following:

- Make sure unit is plugged in.
- Both lamps are inserted properly and rotated 90 degrees.

HG—LAMP CONTAINS MERCURY

Manage in Accordance with Disposal Laws
See: www.lamprecycle.org

Fig. 4

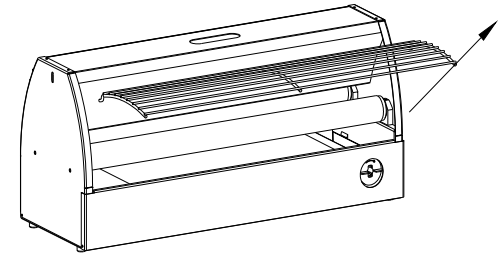

Fig. 5

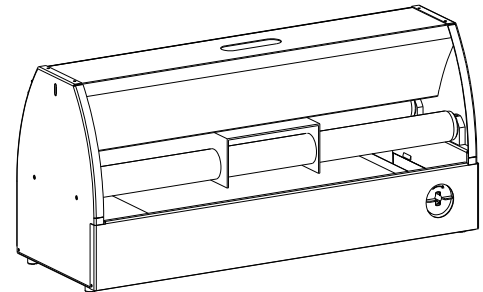
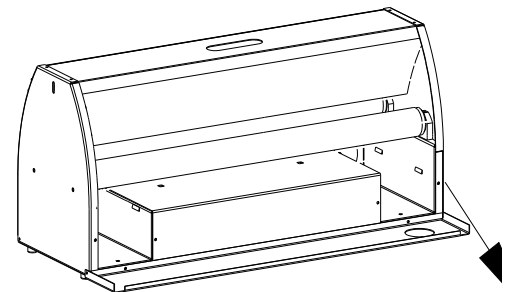

Fig. 6



72955-5-6-2012